

MEKTAL

PIPING SOLUTIONS

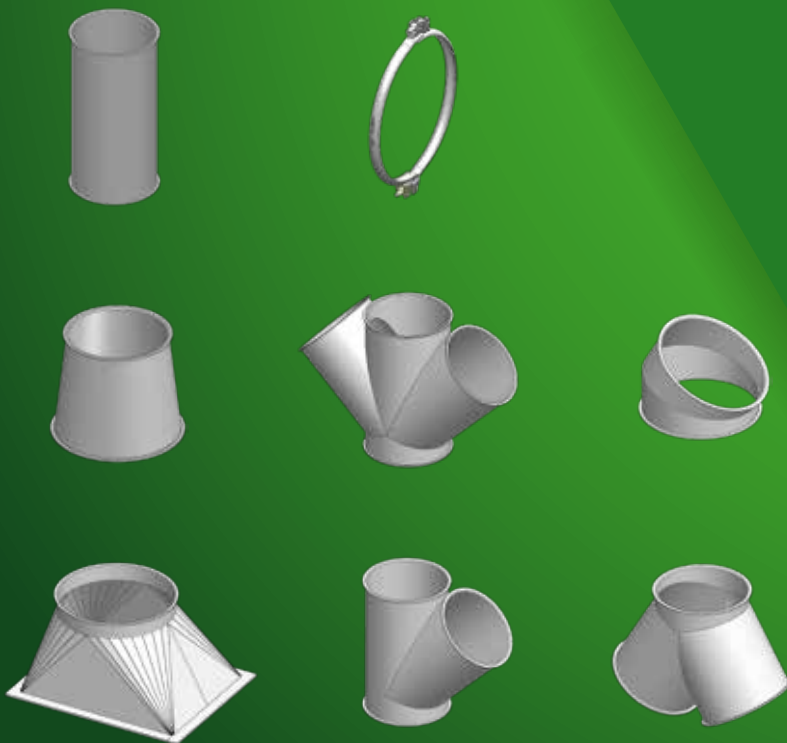

PIPING FOR GRAIN AND BULK

PIPING CLAMP CONNECTED FOR GRAIN

Pipes - clamp connected

Whole piping fittings

Transport devices - bucket elevator, scraper conveyor

www.mektal.pl



About Mektal

Short story about us.

MEKTAL was founded in 1957 in Gdańsk, Poland as family based company. Since 1997 Mektal is located in Puck, 40 km from Gdańsk.

Main specialization of the company is design and production of solutions for gravitational, pneumatic, low-pressure and mechanical transport.

Ready to work.

Grain and feed transport

Mektal offers a system of modular pipelines connected with special clamps. The offer, apart from pipes, includes many devices, fittings and services, thanks to which transport becomes simple, quick and cheap to maintain and work.

Mektal modular pipelines have main advantage apart from warehouse, production capacity ready to work.

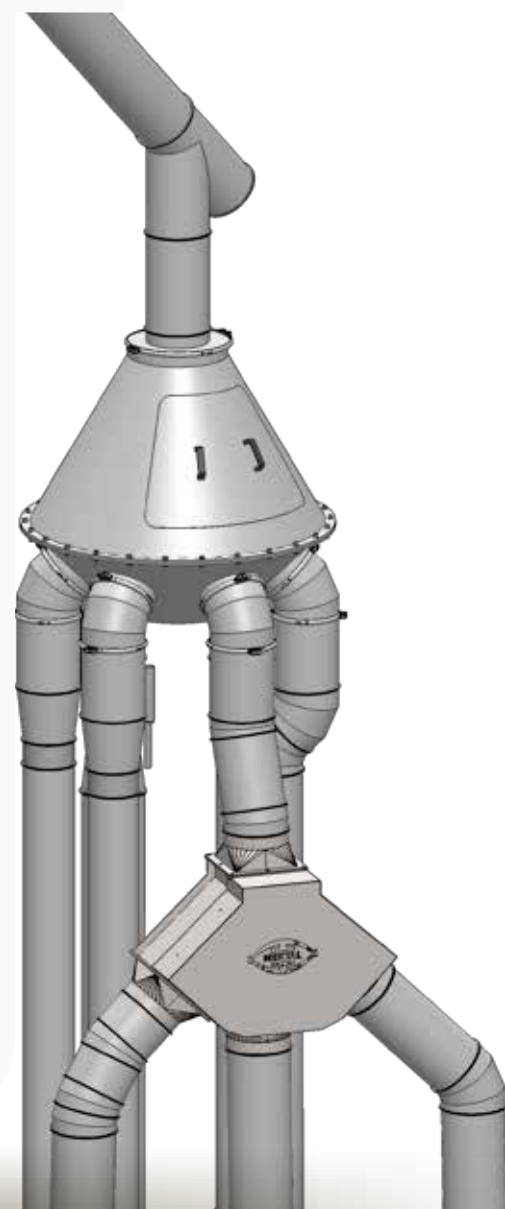
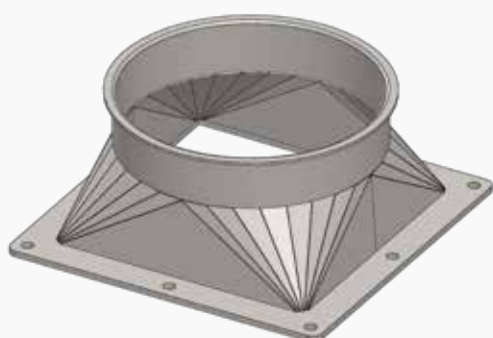

Transport experienced

Gravitational and pneumatic transport

In Mektal, we also manufacture self-supporting, modular, bolted and special tanks. We provide the service of designing and manufacturing tanks for hard-to-flow or clumping materials.

We have designed, created and produced many static and mechanical solutions for clumping materials in tanks cones and sheatings.

The biggest experience in storage for:



Grain



Animal feed



Concentrate feed



Bran



Soda



Silicon dioxide



Quicklime



Basalt flour



Cement



Chalk



Titanium dioxide



Slaked lime



Clamps - pipe connecting

Basic solutions

Pipe thickness connection:

1,5

2,0

3,0

Coating:

ZINC

Sealing:

Butyl

Diameter [mm]:

150

200

250

300

350

400

450

500



KPS flange

Flange - KDW, two system connection

Pipe thickness [mm] :

1,5

2,0

3,0

Protection :

ZINC

HDG

RAL

Diameter [mm]:

150

200

250

300

350

400

450

500

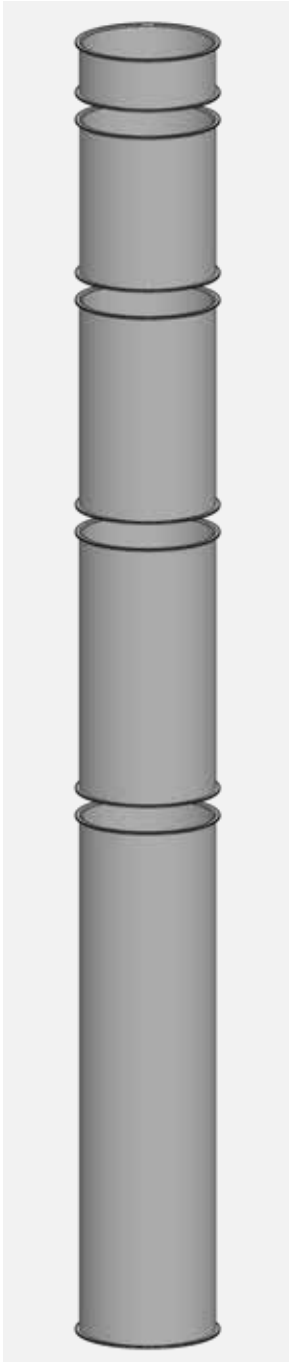

Pipes - clamp connected

Piping solutions

Pipe thickness [mm] :

1,5	2,0	3,0
-----	-----	-----

Protection :

ZINC	HDG	RAL
------	-----	-----

Diameter [mm]:

150	200	250	300	350	400	450	500
-----	-----	-----	-----	-----	-----	-----	-----

Length [mm]:

50	100	150	200	250	300	350	400
450	500	550	600	650	700	750	800
850	900	950	1000				
1500	2000						

Inside coating:

BARE STEEL	EPOXY COATING	POLIURETHANE COATING
------------	---------------	----------------------





KDW

Collar socket for welding

Thickness [mm] :

2,0

3,0

Protection :

RCS

HDG

Diameter [mm]:

150

200

250

300

350

400

450

500

Height [mm] :

50

100

150



KDA

Collar socket for bolting

Thickness [mm] :

2,0

3,0

Protection :

RCS

HDG

RAL

Diameter [mm]:

150

200

250

300

350

400

450

500

Height [mm] :

50

100

150

Flange:

DIN24154

On demand

Inside coating:

BARE
STEEL

EPOXY
COATING

POLIURETHANE
COATING



Segment angles

Piping solutions

Angle thickness [mm] :

2,0

2,5

3,0

Protection :

ZINC

HDG

RAL

Diameter [mm]:

150

200

250

300

350

400

450

500

Angles [deg]:

5°

7,5°

10°

15°

30°

45°

60°

90°

20°

35°

75°

80°

Inside coating:

BARE
STEEL

EPOXY
COATING

POLIURETHANE
COATING



RCS

PUR

Adjustable angle 0°- 55°

Piping solutions

Angle thickness [mm] :

2,0

2,5

3,0

Protection :

ZINC

HDG

RAL

Diameter [mm]:

150

200

250

300

350

400

450

500



RCS PUR

Reduction pipe

Axial reducer pipe

Thickness [mm] :

2,0 3,0

Protection :

RCS HDG RAL

Diameter [mm]:

150 200 250 300 350 400 450 500



RCS PUR

Grain sampler

Grain sampler with inox probe

Thickness [mm] :

2,0 3,0

Protection :

INOX HDG RAL

Diameter [mm]:

150 200 250 300 350 400 450 500

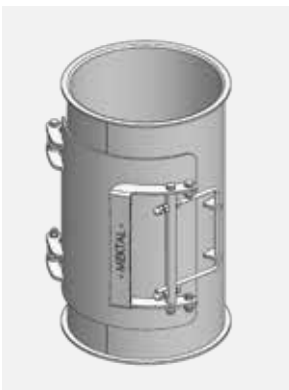

RCS PUR

Inspection pipe

Sealed hatch with large handle

Thickness [mm] :

2,0 3,0

Protection :

RCS HDG RAL

Diameter [mm]:

150 200 250 300 350 400 450 500



RCS PUR

Tee Branch 45°

Splitting tee - break fork 45°

Thickness [mm] :

2,0 3,0

Protection :

RCS HDG RAL

Diameter [mm]:

150 200 250 300 350 400 450 500



RCS PUR

Tee Branch 30°

Splitting tee - break fork 30°

Thickness [mm] :

2,0 3,0

Protection :

RCS HDG RAL

Diameter [mm]:

150 200 250 300 350 400 450 500



RCS PUR

Socket pipe - L=400

Socket with sealing - vertical and horizontal compensation

Thickness [mm] :

3,0

Protection :

RCS HDG RAL

Diameter [mm]:

150 200 250 300 350 400 450 500

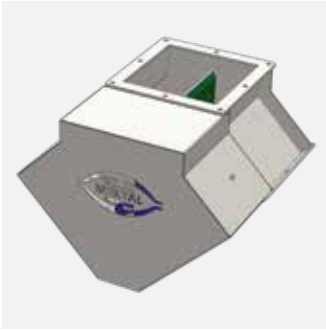

Flap diverter 2-WAY 45°

Flap 2-way diverter 45° symetrical

Types :

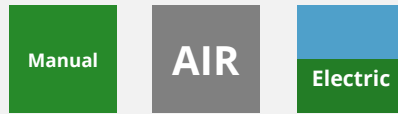

Protection :



Diameter [mm]:

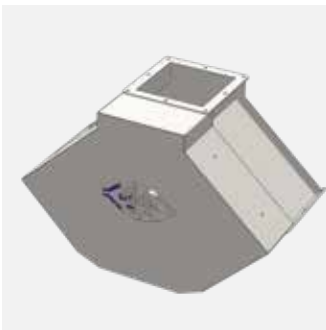
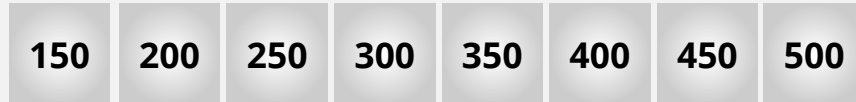

Flap diverter 3-WAY 45°

Flap 3-way diverter 45° symetrical

Types :

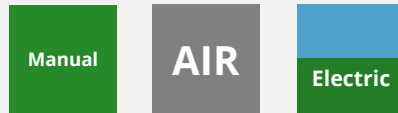

Protection :



Diameter [mm]:

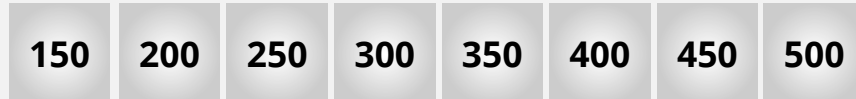

Multi-way distributor

Multi-way distributor - 4, 6, 8, 10, 12, 16 way

Types :

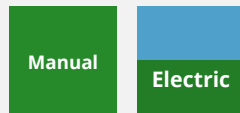

Protection :



Diameter [mm]:

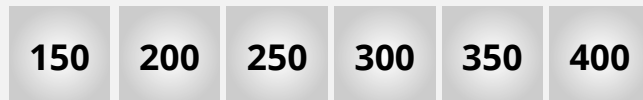



Slidevalve - light

Light version - slidevalve manually operated

Types :

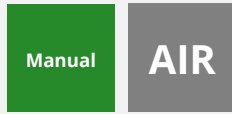

Protection :



Diameter [mm]:

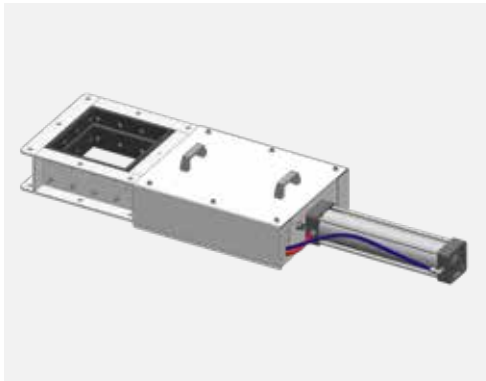
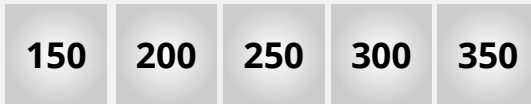

Slidevalve - under redler

Tigh slidevalve under chain instalation

Types :

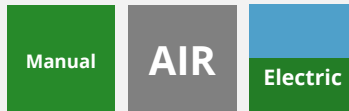

Protection :



Diameter [mm]:

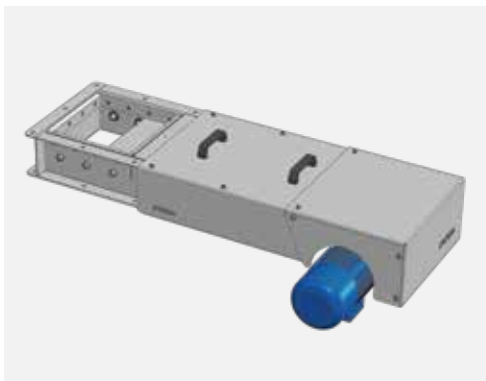
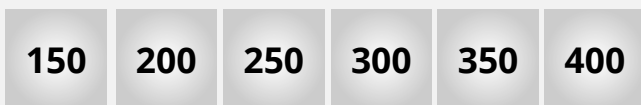

Slidevalve - under silo

Tigh slidevalve under silo instalation

Types :

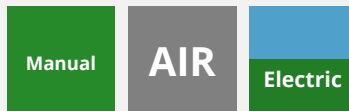

Protection :



Diameter [mm]:

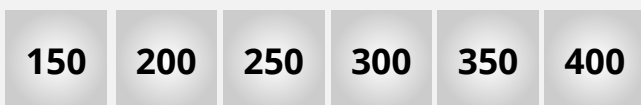



Dystrybutor:

PPUH iT MEKTAL

84-100 Puck, ul. Mestwina 43

VAT PL5870002586

+48 58 774 32 51

info@mektal.pl

www.mektal.pl